



A+ Air *IDU SERIES*



MIXED AIR VENTILATION— THE CLASSIC WAY

In most ventilation systems the goal of space air distribution is to create “well-mixed” environments and the most common form of air distribution is through ceiling diffusers. Supply air is delivered through the diffusers at high velocities to mix the fresh supply air into the room.

When properly executed, this method provides good thermal comfort by keeping the whole occupied zone of a room at a uniform, comfortable temperature.

For the purpose of ventilation, the introduction of fresh air helps to dilute contaminants. Take carbon dioxide (CO₂), one of the most common contaminants that ventilation systems help dilute. If the target CO₂ concentration is 1000 ppm, mixed air ventilation systems inject fresh air with a lower concentration (say 450 ppm) at a rate necessary to offset the CO₂ generation of the occupants and maintain the target setpoint.

The cool, fresh air is rapidly mixed into the space, and this causes the temperature and contaminant levels throughout the occupied zone to be uniform.

While this method works to maintain acceptable levels of contaminants like CO₂ and VOCs, it is intuitively not ideal for protecting occupants from the airborne spread of viruses and bacteria from infected individuals in the same room.

If a sick person is in a room, the ideal scenario would be for the air that person exhales to be immediately exhausted to the outdoors. This is very different than standard mixed air ventilation, where when a sick person exhales, that contaminated air gets mixed all throughout the space before being exhausted.

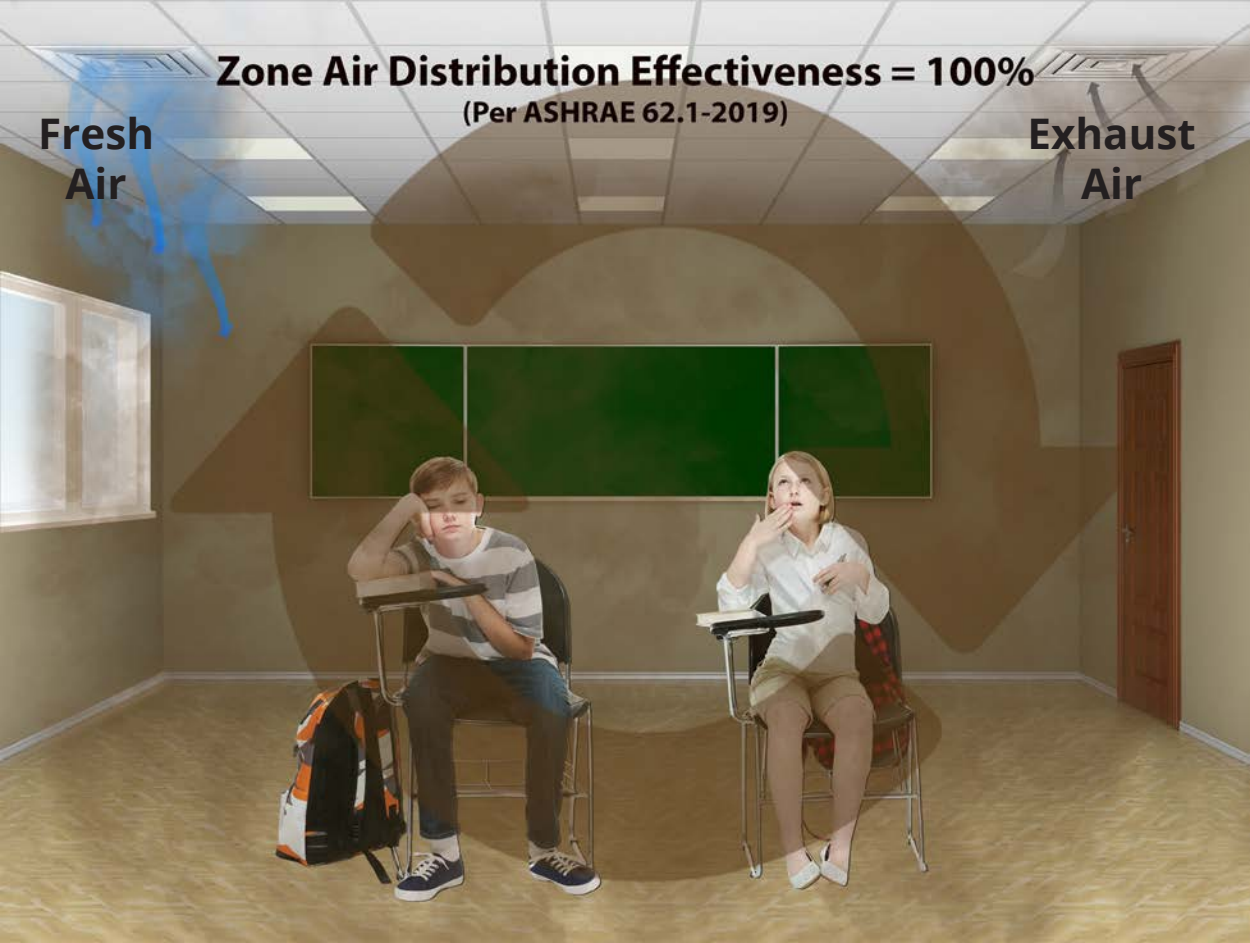

DISPLACEMENT VENTILATION FOR HEALTHIER ENVIRONMENTS

Displacement ventilation provides a better means of achieving high indoor air quality. Rather than creating a well-mixed space, displacement ventilation creates a stratified space in which the air temperature and “freshness” are not uniform. These conditions are created by delivering cool, fresh air horizontally along the floor at a relatively low velocity to facilitate the exhaust of stale air at the ceiling.

Sources of heat in a space, such as occupants, warm the air around them, which rises upward due to buoyancy. In a stratified space, the air near the floor

is the coolest (and freshest), and the air at the ceiling is warmest (and stalest). Warmer, older air rises from the heat sources and gets exhausted at the ceiling. Fresh air rises in its place.

Because of this stratification and the lack of mixing, when a person exhales their warm breath, that air will quickly begin to rise towards the ceiling to be exhausted – without intentionally being mixed throughout the room by traditional air distribution.



OUTSIDE AIR AND ZONE AIR DISTRIBUTION EFFECTIVENESS

Good ventilation is obviously an essential part of achieving good indoor air quality. What's not so obvious is what "good ventilation" means.

The first thought that comes to mind is: "more fresh air equals better ventilation." While that is true, all else being equal, it's not the whole story. In addition, air quality in a space also depends on HOW that fresh air is delivered.

One of the most widely known functions of ASHRAE Standard 62.1 (Ventilation for Acceptable Indoor Air Quality) is that it specifies how to calculate the flow rate of outdoor air required for various types of indoor spaces.

The required flow rate depends on the type of space, the number of occupants, the area of the room, and the air distribution configuration of the space, quantified by a parameter called zone air distribution effectiveness (E_z).

Zone air distribution effectiveness describes an air distribution system's ability to remove internally generated pollutants. Specifically, it is a measure of how much higher the contaminant concentration of the exhaust air is than that of the breathing zone air. In a "perfectly-mixed" space, that value is 1.0, but in a stratified space it is typically higher than one. E_z can be calculated by the below equation (C-1 from 62.1):

$$E_z = (C_e - C_s) / (C - C_s) \quad \text{C-1}$$

where

- E_z = zone air distribution effectiveness
- C = average contaminant concentration at the breathing zone
- C_e = average contaminant concentration at the exhaust
- C_s = average contaminant concentration at the supply

The previous equation can be used to determine E_z in the design stage, but it often isn't because it requires detailed computational modeling to determine the concentrations. Alternatively, table 6.4 of the standard provides default values that can be used for various system types, without any modeling required. With E_z known, the required outdoor airflow to a zone can be calculated by the equation:

$$OA\ CFM = \frac{\frac{CFM}{person} \cdot people + \frac{CFM}{sqft} \cdot sqft}{Zone\ air\ distribution\ effectiveness\ (E_z)}$$

table 6.4 gives a default value of 1.2 (or 1.5 if the ceiling is over 18ft) for properly designed displacement ventilation systems, with the description:

- Floor supply of cool air where the vertical throw is less than 60 fpm (0.25 m/s) at a height of 4.5 ft (1.4 m) above the floor and ceiling return at a height less than or equal to 18 ft (5.5 m) above the floor.

Given the above definition, heating with induction displacement units must be considered. A classroom designed with constant volume primary air (based on $E_z = 1.2$) will not be compliant with ASHRAE 62.1 during heating mode if the heating is supplied via warm air at floor level. In the above description, "cool air" is defined as being at least 4°F below the average room temperature. The Dadanco IDU series is designed to achieve true displacement ventilation year-round, even on the coldest winter days, because space heating is provided separately from the ventilation air, which always remains cool.

The below table compares the zone air distribution effectiveness of displacement ventilation, as described above, with that of ceiling supply of cold air, and floor supply of warm air (with ceiling return). Also shown are the outdoor air flow rates that would be required for each configuration, for a 1056-square-foot classroom with 30 occupants.

AIR DISTRIBUTION CONFIGURATION	ZONE AIR DISTRIBUTION EFFECTIVENESS	OUTDOOR AIR CFM REQUIRED
CEILING SUPPLY OF COOL AIR	1.0	427
FLOOR SUPPLY OF WARM AIR AND CEILING RETURN	0.7	610
DISPLACEMENT VENTILATION	1.2	356

DUAL COIL DISPLACEMENT UNITS

As stated in the ASHRAE 62.1 definition, displacement ventilation only works when the floor-level supply air is cool. The supply air needs to be colder (denser) than the rest of the air in the space to create thermal stratification.

If the supply air from a displacement unit is warm, it is less dense than the surrounding air and rises upwards as soon as it leaves the terminal. Further, the supply air's low velocity results in minimal horizontal "throw" into the room. As a result, the fresh air rises quickly upward above the heads of the occupants and doesn't enter their breathing zone. The fresh air at the ceiling is eventually exhausted from the space by the ceiling return. There is nothing that forces that warm fresh air down to the occupants.

This issue of heating with displacement ventilation is solved by having a separate source of heating that does not interfere with the cool air displacement process.

Dadanco offers two dual-coil induction displacement unit models that achieve this by having separate hydronic heating coils and warm air outlets that provide space heating independent of the displacement ventilation air.

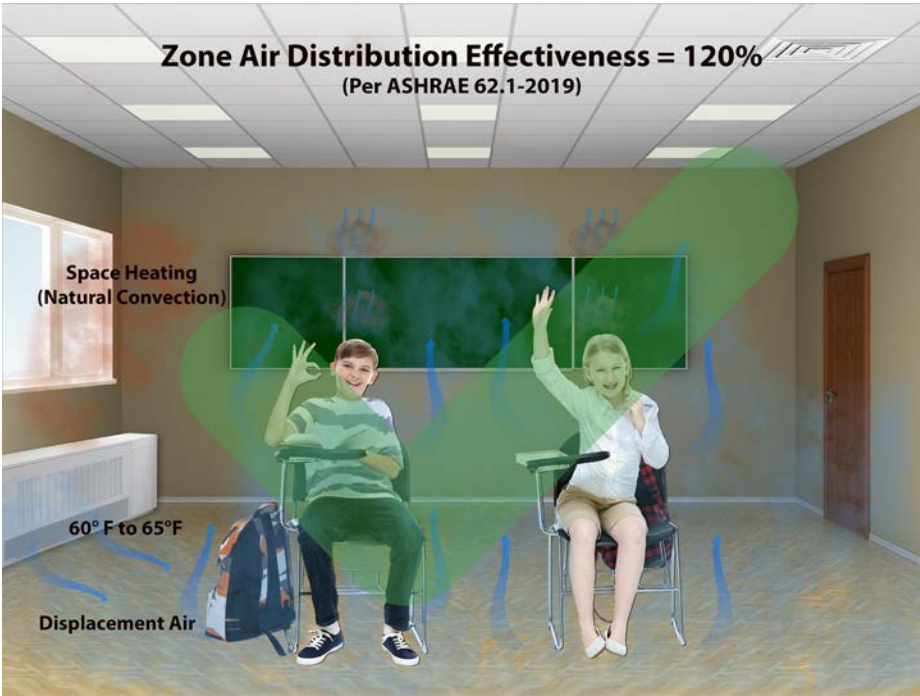

IDU MODELS

The Dadanco IDU product line includes three models of induction displacement units and a full line of customizable cabinetry, with shelving sections, duct chases and more.

IDU10 | DUAL COIL

Dual Coil with Top Outlet Heating

All primary air is supplied horizontally along the floor through the bottom of the front panel. It is delivered cool, in true displacement mode year-round, regardless of weather and load conditions.

A natural convection coil on top of the unit provides heating. Room air enters the heating coil from the top of the front panel and exits the top of the cabinet along the rear wall. Total cabinet depth is 16". The perforated heating outlet takes up 6" of top panel depth near the exterior wall/window. The front 10" of the cabinet top is solid and can be used for storage.

Heating is dependent on hot water flow only, primary air is not required. Night setback heating can be done without turning on the air system. In heating mode, temperature control can be completely decoupled from the air-side of the system.

The IDU10 is designed for maximum heating capacity and is capable of highly efficient heating with lower water temperatures. With approximately 600BTUH/foot heating output with 120 °F entering hot water, the IDU10 can allow the utilization of condensing boilers or heat pumps, even in cold climates.

Heating coils are most commonly piped in parallel for maximum capacity, but this comes at the expense of relatively low ΔT and high flow. If applied in a building with a high-quality envelope (and therefore low heating load), the IDU10 heating coils can be piped in series for a more energy-efficient heating system. If loads allow, each typical classroom could go from a 5-10 °F ΔT to a 20-30°F ΔT with a much lower flow rate, reducing pumping energy and hot water pipe sizes.

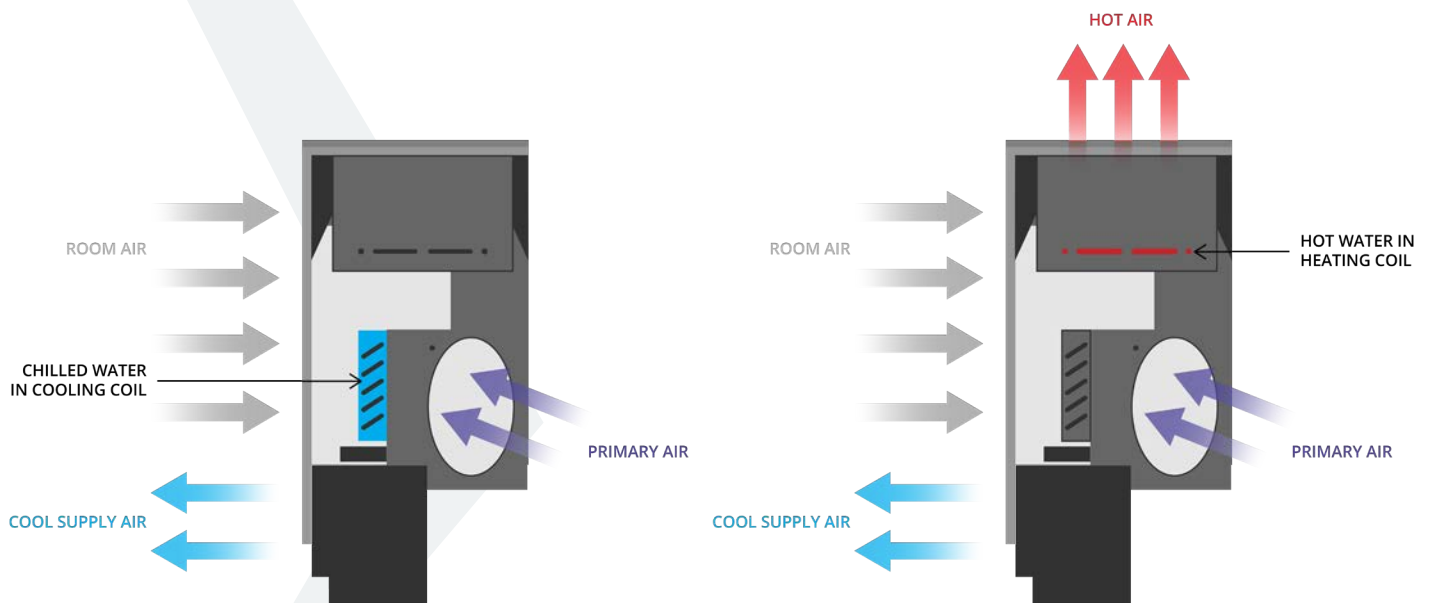

COOLING OPERATION

HEATING OPERATION



The Optimal Solution For Cold Climates

IDU10 PERFORMANCE SUMMARY

NOMINAL UNIT LENGTH	MAX RECOMMENDED PRIMARY AIRFLOW	TYPICAL COOLING CAPACITY	TYPICAL HEATING CAPACITY (COIL) 120 EWT	TYPICAL HEATING CAPACITY (COIL) 140 EWT	TYPICAL HEATING CAPACITY (COIL) 160 EWT	TYPICAL HEATING CAPACITY (COIL) 180 EWT
FT	CFM	BTU/H				
4	80	3250	2400	3775	5275	6950
5	100	4200	3100	4825	6775	8875
6	125	5150	3775	5875	8225	10775
7	150	6150	4425	6875	9600	12575

PERFORMANCE NOTES:

- 58–61°F Entering CHW temp, heating temperatures (EWT) shown on table
- No glycol in CHW or HW
- 1.5 GPM water flow in heating, 0.5–2.0 GPM in cooling (as needed to achieve 60–63°F supply air temp)
- Room design: 75°F cooling, 70°F heating
- Primary air temperatures: 50–60°F cooling (must be dehumidified regardless of temperature), 60°F heating
- Cooling capacity based on 18°F exhaust-supply air temperature differential with 70 FPM outlet velocity
- Typical primary air pressure drop: 0.1–0.4"
- Sea-level elevation

IDU10HO - IDU10 HEATING ONLY

For schools in cold climates, the chilled water portion of the IDU system may not be required. Especially with school not in session during the summer, the primary air alone may provide adequate space cooling. First costs are reduced substantially by eliminating all piping and system components associated with the chilled water.

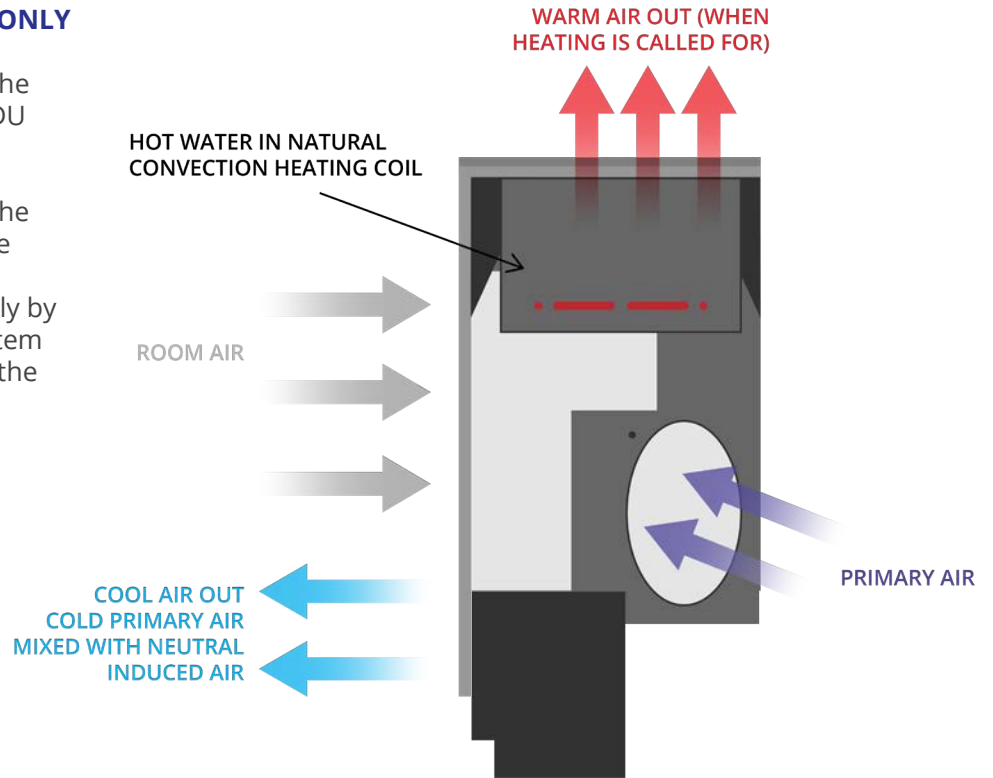

The heating only IDU10 unit uses a slotted plate in place of the cooling coil, designed to produce the same airflow performance as a standard IDU10 unit with cooling coil.



I10HC - IDU10 HEATING ONLY CABINET

For IDU10 applications with excess perimeter wall space. Identical cabinetry to IDU10 units, containing the same heating coil assemblies. Can be used to provide wall-to-wall heating when units do not cover the whole perimeter wall. Piping and 8" duct can be run through this cabinet, allowing it to be installed anywhere within a run of IDU10 cabinetry.

Provides the highest heating capacity—more than IDU10 units and both heating shelf models.



DCTHS - DUCTED IDU10 HEATING SHELF

For IDU10 applications with excess perimeter wall space. Shelving section with a heating coil assembly in the rear that is driven by natural convection, similar to the IDU10. Can be used to provide wall-to-wall heating when units do not cover the whole perimeter wall.

Shelving is 7" deep x 22" high. Comes standard with one movable shelf. Top panel includes perforated heating outlet identical to that of IDU10 units.

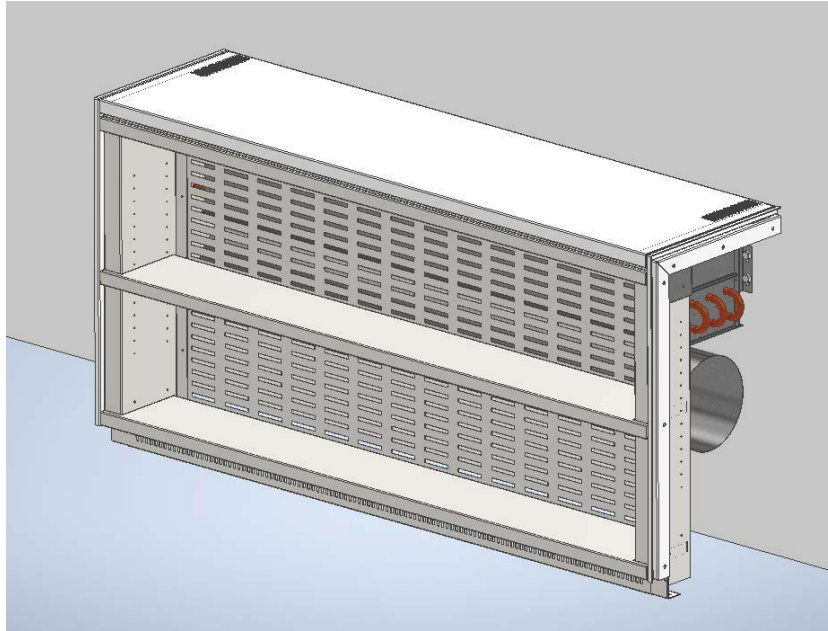

Return air enters from underneath, and through the back of the shelving. The full back of the shelving is slotted due to how the ductwork running underneath the coil can block much of the return air path.

Piping and ductwork can both fit behind the shelving, allowing it to work every layout. However, the shelving is not as deep and the heating capacity is not as high as the non-ducted model.

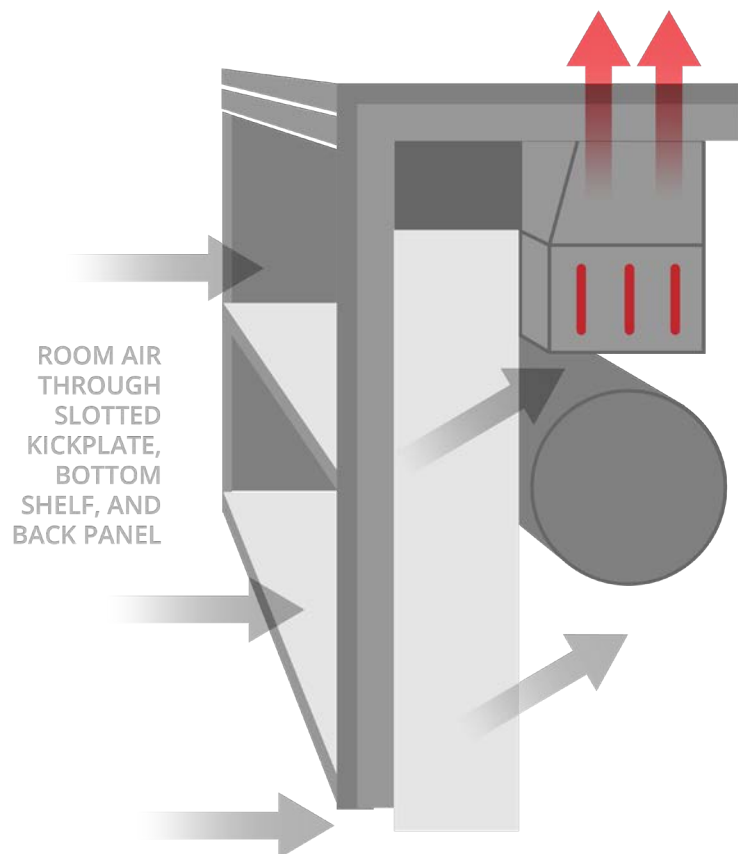

110HS - IDU10 HEATING SHELF

For IDU10 applications with excess perimeter wall space. Shelving section with a heating coil assembly in the rear that is driven by natural convection, similar to the IDU10. Can be used to provide wall-to-wall heating when units do not cover the whole perimeter wall.

Shelving is 10" deep x 22" high. Comes standard with one movable shelf. Top panel includes perforated heating outlet identical to that of IDU10 units.

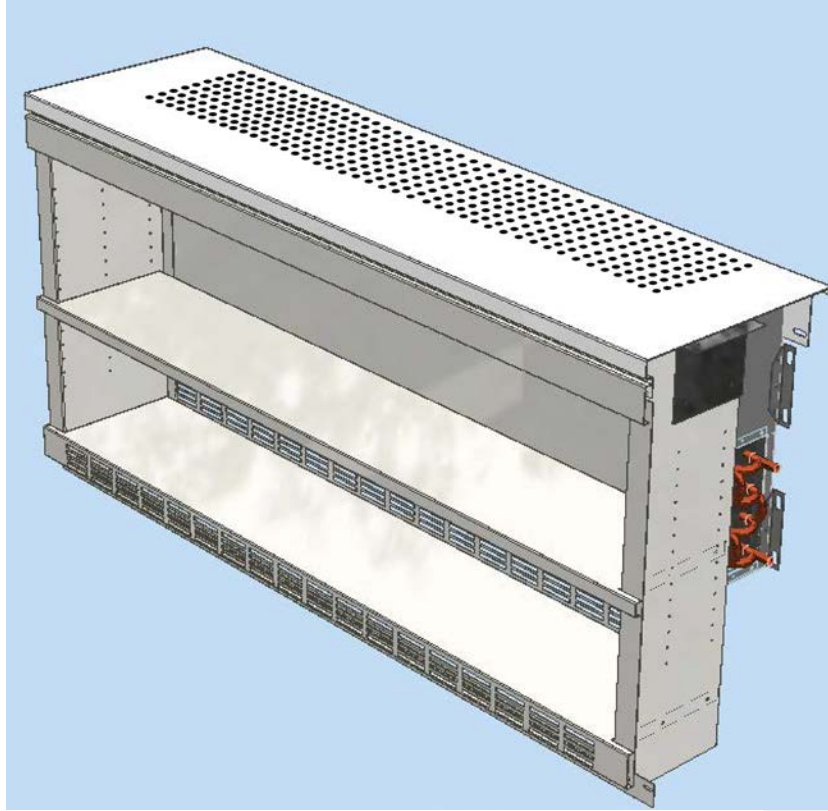

Return air enters from underneath, and through the back of the shelving (lower portion only).

Piping can be run underneath the coil, but ductwork cannot, meaning it does not fit in every layout. However, the extra space gained by not allowing for ductwork enables this model to have significantly deeper shelves, and higher heating capacity than the ducted model.

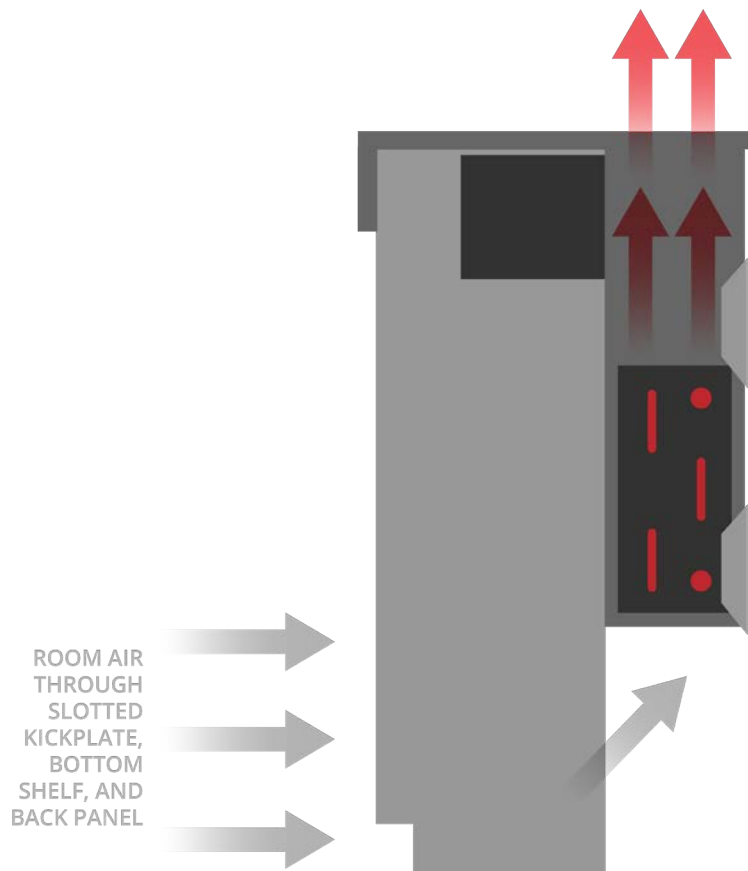

IDU20 | DUAL COIL

Dual Coil with Front Outlet Heating

Dual induction coils with common plenum, one for heating, one for cooling and displacement ventilation.

Cooling/displacement air is supplied along the floor through the bottom of the front panel, and heating air is supplied out the top of the front panel. 80-90% of primary air is used for displacement ventilation and cooling. The remaining 10-20% of primary air drives the heating coil.

A common primary air plenum and single duct connection feeds both induction coils. Each coil has an associated bank of induction nozzles sized to provide the design primary airflows for heating and cooling at a common design pressure. Primary airflow is required for the IDU20 to provide significant heating capacity.

Since the heating airflow is low-level warm air, it does not have the ventilation effectiveness that the cooling airflow does. The warm air leaves the front of the cabinet at a low velocity and immediately rises upward near the perimeter wall. While this effectively offsets perimeter heat loss, it is not effective at ventilating, as the fresh air never reaches the occupants. Therefore, the heating portion of the primary air "does not count" towards the required ventilation rate of the zone.

Because the heating coil is an induction coil driven by the primary air, the air system must be on to provide a significant amount of space heating. Operators can provide night setback heating by supplying 100% recirculated air to the IDU20 units in the unoccupied spaces.

For those two reasons, the IDU20 does not perform as well as the IDU10 from a technical standpoint. The IDU20 exists for applications in which a solid cabinet top with no perforation or heating outlets is critical.

Though not as effective as the IDU10, the IDU20 offers a solid cabinet top and far better performance than single coil units.

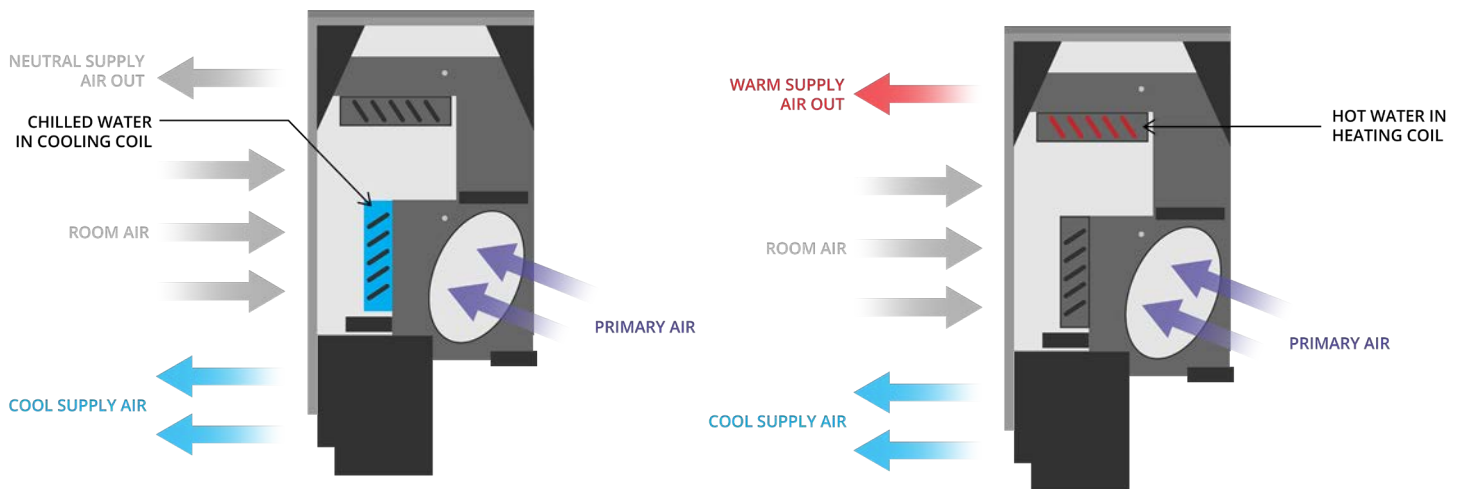

COOLING OPERATION

HEATING OPERATION



IDU20 PERFORMANCE SUMMARY

NOMINAL UNIT LENGTH	MAX RECOMMENDED PRIMARY AIR FLOW RATE (COOLING/DISPLACEMENT)	(RECOMMENDED) HEATING PRIMARY AIR FLOW	(MAX) TOTAL PRIMARY AIR FLOW	NET UNIT SENSIBLE COOLING BTU/H	TYPICAL HEATING CAPACITY (COIL) 120 EWT	TYPICAL HEATING CAPACITY (COIL) 140 EWT	TYPICAL HEATING CAPACITY (COIL) 160 EWT	TYPICAL HEATING CAPACITY (COIL) 180 EWT
FT	CFM			BTU/H				
4	80	14	94	3250	2700	3800	4900	6050
5	100	18	118	4200	3475	4850	6200	7575
6	125	22	147	5150	4125	5750	7350	9000
7	150	25	175	6150	4800	6725	8650	10600

PERFORMANCE NOTES:

- 58–61°F Entering CHW temp, heating temperatures (EWT) shown on table
- No glycol in CHW or HW
- 1.5 GPM water flow in heating, 0.5–2.0 GPM in cooling (as needed to achieve 60–63°F supply air temp)
- Room design: 75°F cooling, 70°F heating
- Primary air temperatures: 50–60°F in cooling (must be dehumidified regardless of temperature), 60°F heating
- Typical primary air pressure drop: 0.1"–0.4", Heating Capacities based on 0.35"
- Sea-level elevation
- Cooling capacity based on 18°F exhaust-supply air temperature differential with 70 FPM outlet velocity

I20HS - IDU20 HEATING SHELF

For IDU20/30 applications with excess perimeter wall space. Shelving section includes a heating coil assembly in the rear that is driven by natural convection, and has a front outlet. Can be used to provide wall-to-wall heating when units do not cover the whole perimeter wall.

Shelving is 10" deep x 18" high. Comes standard with one movable shelf. Uses solid top panels, identical to those of IDU20/30 units.

Piping can be run underneath the coil, but ductwork cannot.

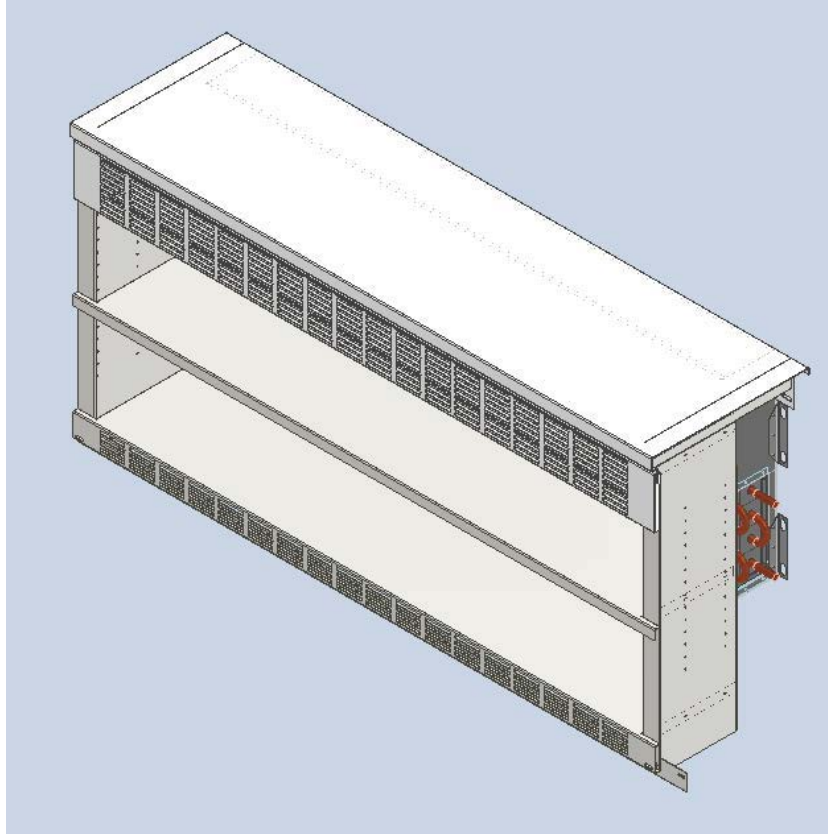

Return air enters from underneath, and through the back of the shelving (lower portion only).

Heat exits through the louvered or perforated front panel above the shelving.

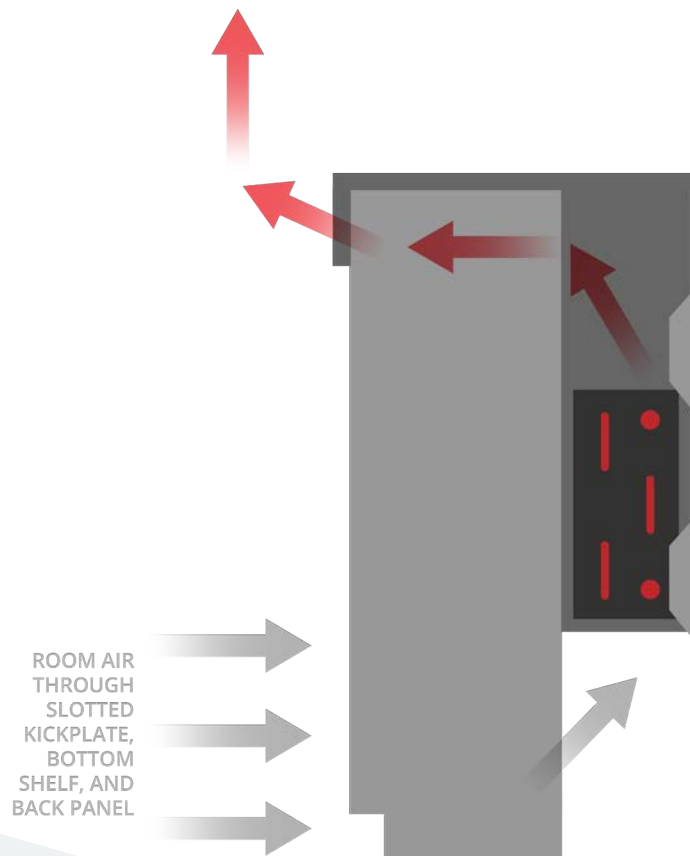

I20HC - IDU20 HEATING ONLY CABINET

For IDU20 applications with excess perimeter wall space. Identical cabinetry to IDU20 units, containing only heating coil assemblies. Unlike the IDU20 units, these heating coils function by natural convection only, providing heat without primary airflow.

Like the IDU20 units, heating is delivered through the top portion of the front panel. The top panel is solid.

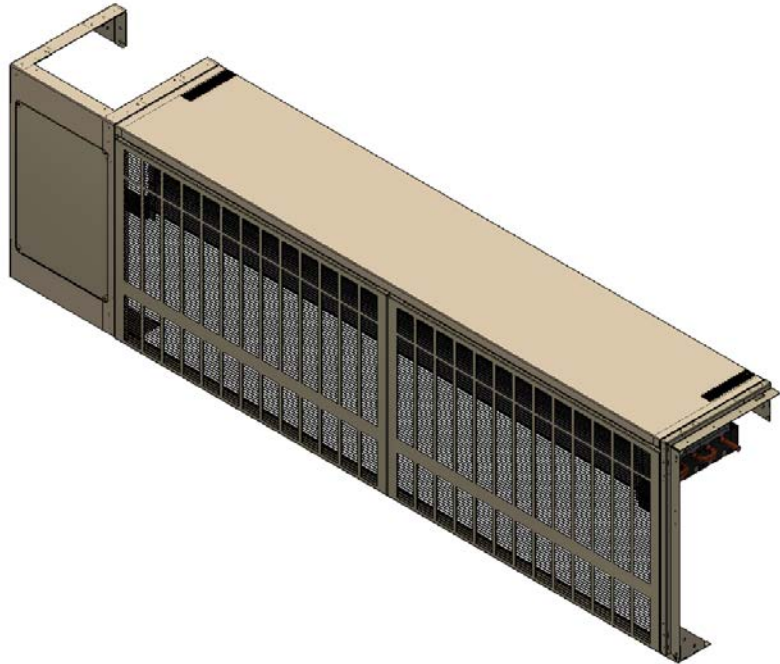

Can be used to provide wall-to-wall heating when units do not cover the whole perimeter wall. Piping and 8" duct can be run through this cabinet, allowing it to be installed anywhere within a run of IDU20 cabinetry.

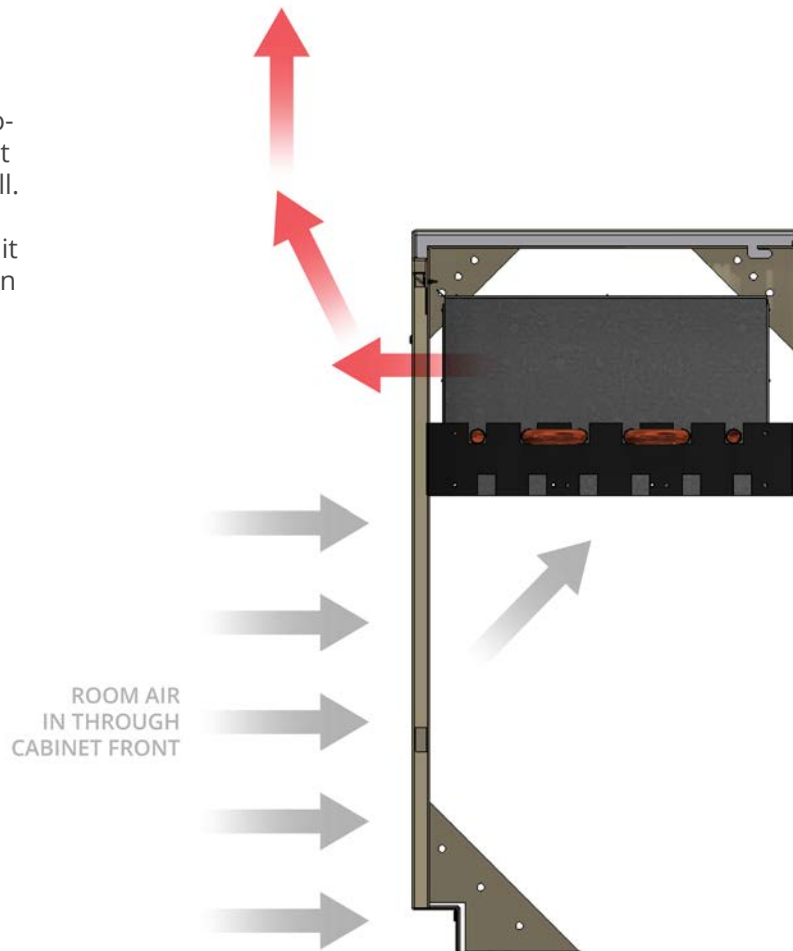

SHELVING SECTION

For IDU10, 20, or 30 applications with excess perimeter wall space that do not require additional heating beyond that provided by the units. Uses solid top panels, identical to those of IDU20/30 units.

Shelving is 7" deep x 22" high. Comes standard with one movable shelf.

Shelving depth allows for pipe and ductwork to be run behind the shelving, allowing these sections to be placed anywhere within a run of IDU cabinetry.

Deeper shelving sections can be provided on request if the application does not require ductwork run behind.

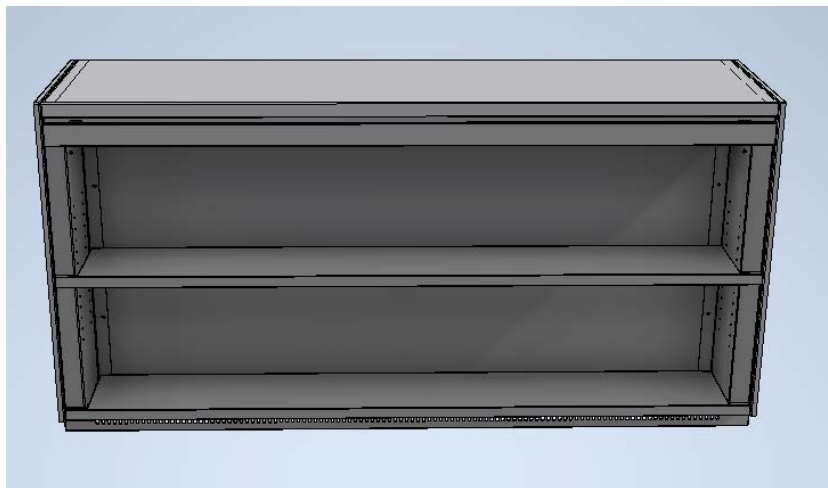
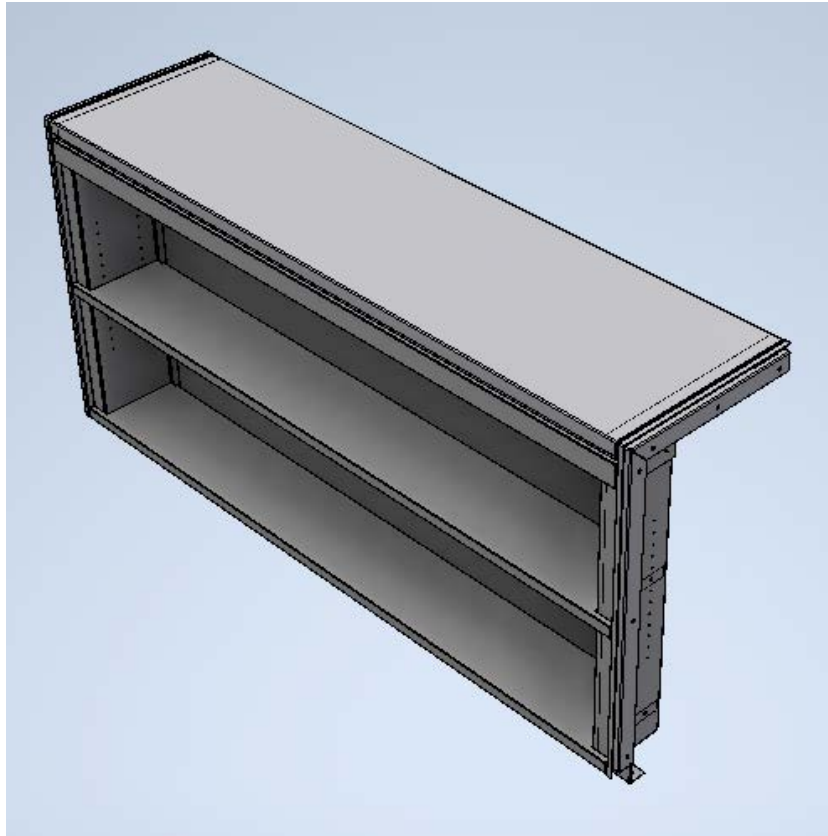

DISPLACEMENT
UNITS IDU 10



**DADANCO
IDU SERIES**

FOR AN ENERGY EFFICIENT IDU TEMPERATURE
HYDRA-COIL™ DESIGN
MINIMIZE YOUR CARBON FOOTPRINT TODAY!

SINGLE COIL IDU

FOR A SINGLE COIL ONLY OF
CONSTRUCTION

DUAL COIL IDU

STANDARD DADANCO DESIGN



AIRFLOW AND SOUND DATA | IDU20

7' NOMINAL UNIT WITH 8" ELLIPTICAL CONNECTIONS					NUMBER OF UNITS DUCTED IN SERIES		
					1	2	3
DISPLACEMENT PRIMARY AIR FLOW (CFM)	HEATING PRIMARY AIR FLOW (CFM)	DISPLACEMENT SUPPLY AIR FLOW (CFM)	HEATING SUPPLY AIR FLOW (CFM)	PRIMARY AIR PRESSURE (IN W.C.)	SOUND LEVEL (NC)		
100	25	250	135	0.35" (APPROX.)	<15	20	28
110		265			<15	21	30
120		280			<15	23	33
130		295			<15	24	34
140		305			15	25	35
150		315*			16	27	38

6' NOMINAL UNIT WITH 8" ELLIPTICAL CONNECTIONS					NUMBER OF UNITS DUCTED IN SERIES		
					1	2	3
DISPLACEMENT PRIMARY AIR FLOW (CFM)	HEATING PRIMARY AIR FLOW (CFM)	DISPLACEMENT SUPPLY AIR FLOW (CFM)	HEATING SUPPLY AIR FLOW (CFM)	PRIMARY AIR PRESSURE (IN W.C.)	SOUND LEVEL (NC)		
75	22	205	118	0.35" (APPROX.)	<15	16	23
85		220			<15	18	25
95		230			<15	19	27
105		240			<15	20	29
115		255			<15	22	31
125		265*			16	23	33

5' NOMINAL UNIT WITH 8" ELLIPTICAL CONNECTIONS					NUMBER OF UNITS DUCTED IN SERIES		
					1	2	3
DISPLACEMENT PRIMARY AIR FLOW (CFM)	HEATING PRIMARY AIR FLOW (CFM)	DISPLACEMENT SUPPLY AIR FLOW (CFM)	HEATING SUPPLY AIR FLOW (CFM)	PRIMARY AIR PRESSURE (IN W.C.)	SOUND LEVEL (NC)		
50	18	145	95	0.35" (APPROX.)	<15	<15	17
60		160			<15	<15	19
70		175			<15	15	21
80		190			<15	17	23
90		205			<15	18	25
100		215*			<15	19	27

4" NOMINAL UNIT WITH 8" ELLIPTICAL CONNECTIONS					NUMBER OF UNITS DUCTED IN SERIES		
					1	2	3
DISPLACEMENT PRIMARY AIR FLOW (CFM)	HEATING PRIMARY AIR FLOW (CFM)	DISPLACEMENT SUPPLY AIR FLOW (CFM)	HEATING SUPPLY AIR FLOW (CFM)	PRIMARY AIR PRESSURE (IN W.C.)	SOUND LEVEL (NC)		
40	14	115	75	0.35" (APPROX.)	<15	<15	<15
50		130			<15	<15	15
60		145			<15	<15	17
70		155			<15	15	19
80		165*			<15	16	21

PERFORMANCE NOTES:

*Indicates that a supply air flow is the maximum recommended for a given length, these values correspond to an outlet velocity of 70 FPM. Nozzle configuration and primary air pressure should always be selected to keep supply air flow at or below these levels.

Sound levels shown are valid for 0.35" primary air pressure. Sound increases with increasing primary air pressure as well as flow.

Primary air pressure is always equal for heating and displacement flows. Nozzles are selected for each such that both design primary airflows coincide with the same pressure drop.

Many nozzle configurations are available to achieve different displacement supply air flows and temperatures for a given unit length and primary airflow. These are selected to best meet the requirements of each project.

Heating Primary Airflows can also be varied, but the values shown are recommended to maximize heating capacity and not create uncomfortable air velocities when the unit is not heating.

IDU30 | SINGLE COIL

2-Pipe Changeover or 4-Pipe

All supply air, cooling, and heating is supplied at floor level through the bottom of the front panel. This model is generally not recommended for cold climates since warm heating air is delivered at floor level.

If all units in a room are heating in this manner, the ventilation effectiveness will be 0.7, per ASHRAE 62.1. The warm supply air will immediately rise upon leaving the cabinet and not reach the occupants across the room.

With multiple units in a room, it's possible to get better (but still sub-optimal) results by supplying hot

water to only some of the units in the space. The units without hot water will ventilate effectively, but those with hot water will be sending the fresh air directly up to the ceiling, bypassing the occupants.

For example, assume four units are in a room, each delivering 100 CFM of fresh air. The units are staged where two are served by one heating control valve. The first responds to calls for heating, while the other two units do not receive hot water flow. When the room goes into heating mode, only 200 CFM (out of the total 400 CFM) of fresh air will actually reach the occupants.

In cold climates, there may be cases where the first stage of heating is insufficient to keep the room warm — then the second control valve opens up and all four units are supplying warm air.

It is important to note that even with staged heating control, ASHRAE does not allow for any ventilation effectiveness over 0.7 in calculating the required outside airflow rate.

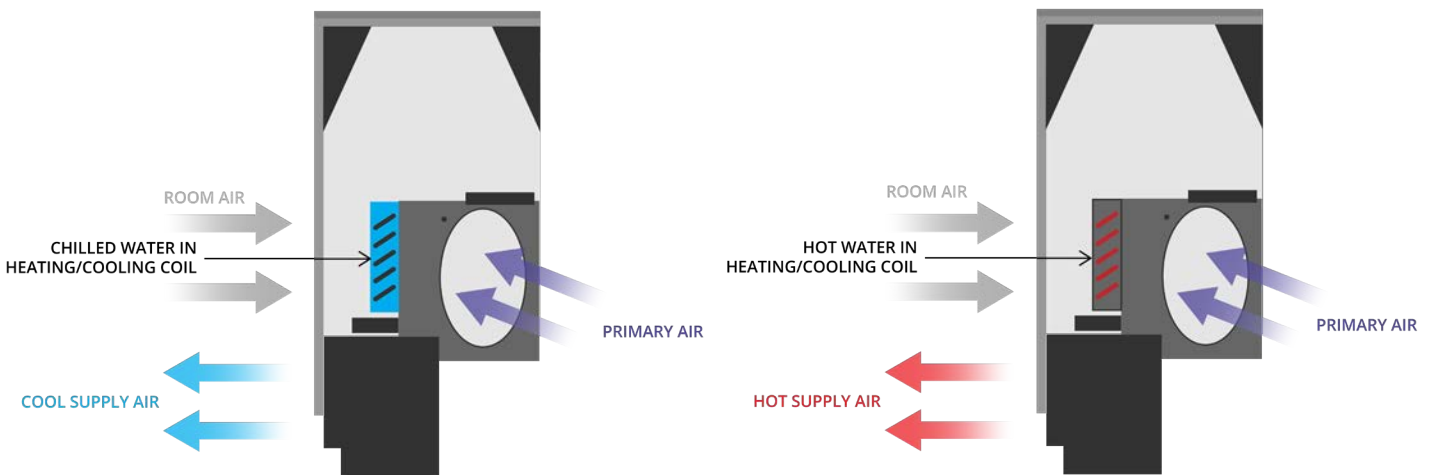

COOLING OPERATION HEATING OPERATION



IDU30 PERFORMANCE SUMMARY (PER UNIT)

NOMINAL UNIT LENGTH	MAX RECOMMENDED PRIMARY AIRFLOW	TYPICAL COOLING CAPACITY (2-PIPE COIL)	TYPICAL HEATING CAPACITY (2-PIPE COIL)	TYPICAL HEATING CAPACITY (4-PIPE COIL)
FT	CFM	BTU/H		
4	80	3250	4400	3600
5	100	4200	6000	4950
6	125	5150	6800	5600
7	150	6150	8200	6750

PERFORMANCE NOTES:

- 58–61°F Entering CHW temp, 140°F heating
- No glycol in CHW or HW
- 1.5 GPM water flow in heating, 0.5–2.0 GPM in cooling (as needed to achieve 60–63°F supply air temp)
- Room design: 75°F cooling, 70°F heating
- Primary air temperatures: 50–60°F in cooling (must be dehumidified regardless of temperature), 60°F heating
- Typical primary air pressure drop: 0.1–0.4", Heating capacities based on 0.35"
- Sea-level elevation
- Heating capacities are net sensible capacities, including the effect of primary air
- Heating capacities based on units selected with the corresponding "max recommend primary airflow"
- Cooling capacities based on 18°F exhaust-supply air temperature differential with 70 FPM outlet velocity

AIRFLOW AND SOUND DATA | IDU10 & 30

7' NOMINAL UNIT WITH 8" ELLIPTICAL CONNECTIONS			NUMBER OF UNITS DUCTED IN SERIES		
			1	2	3
PRIMARY AIR FLOW (CFM)	SUPPLY AIR FLOW (CFM)	PRIMARY AIR PRESSURE (IN W.C.)	SOUND LEVEL (NC)		
100	250	0.35" (APPROX.)	15	21	27
110	265		15	22	29
120	280		16	23	31
130	295		16	25	33
140	305		17	26	35
150	315*		18	27	37

6' NOMINAL UNIT WITH 8" ELLIPTICAL CONNECTIONS			NUMBER OF UNITS DUCTED IN SERIES		
			1	2	3
PRIMARY AIR FLOW (CFM)	SUPPLY AIR FLOW (CFM)	PRIMARY AIR PRESSURE (IN W.C.)	SOUND LEVEL (NC)		
75	205	0.35" (APPROX.)	<15	18	22
85	220		<15	19	24
95	230		<15	20	26
105	240		15	21	28
115	255		15	23	30
125	265*		16	24	32

5' NOMINAL UNIT WITH 8" ELLIPTICAL CONNECTIONS			NUMBER OF UNITS DUCTED IN SERIES		
			1	2	3
PRIMARY AIR FLOW (CFM)	SUPPLY AIR FLOW (CFM)	PRIMARY AIR PRESSURE (IN W.C.)	SOUND LEVEL (NC)		
50	145	0.35" (APPROX.)	<15	15	18
60	160		<15	16	19
70	175		<15	17	21
80	190		<15	18	23
90	205		<15	19	25
100	215*		15	21	27

4' NOMINAL UNIT WITH 8" ELLIPTICAL CONNECTIONS			NUMBER OF UNITS DUCTED IN SERIES		
			1	2	3
PRIMARY AIR FLOW (CFM)	SUPPLY AIR FLOW (CFM)	PRIMARY AIR PRESSURE (IN W.C.)	SOUND LEVEL (NC)		
40	115	0.35" (APPROX.)	<15	<15	15
50	130		<15	<15	17
60	145		<15	15	19
70	155		<15	16	20
80	165*		<15	18	22

PERFORMANCE NOTES:

*Indicates that a supply air flow is the maximum recommended for a given length, these values correspond to an outlet velocity of 70 FPM. Nozzle configuration and primary air pressure should always be selected to keep supply air flow at or below these levels.

Sound levels shown are valid for 0.35" primary air pressure. Sound increases with increasing primary air pressure as well as flow.

MIXED AIR SYSTEMS— *THE CLASSIC WAY*

Traditional Mixed Air System

Much like how it makes sense to avoid mixing germs or other contaminants between individuals in a room, it is also desirable to avoid mixing between different rooms in a building. However, most HVAC systems do this regularly by recirculating air at the air-handling equipment. The air supplied to spaces by HVAC systems is typically only 15-50% fresh air, depending on application specifics—the rest is stale air recirculated from all over the building.

Of course, that stale air is filtered before being resupplied throughout the building, but filtration is never perfect. The only way to guarantee that unwanted contaminants in the return air are not recirculated is to not recirculate air at all.

1: CONTAMINANTS ARE INTRODUCED IN A SINGLE ROOM; A SICK PERSON COUGHING, FOR EXAMPLE

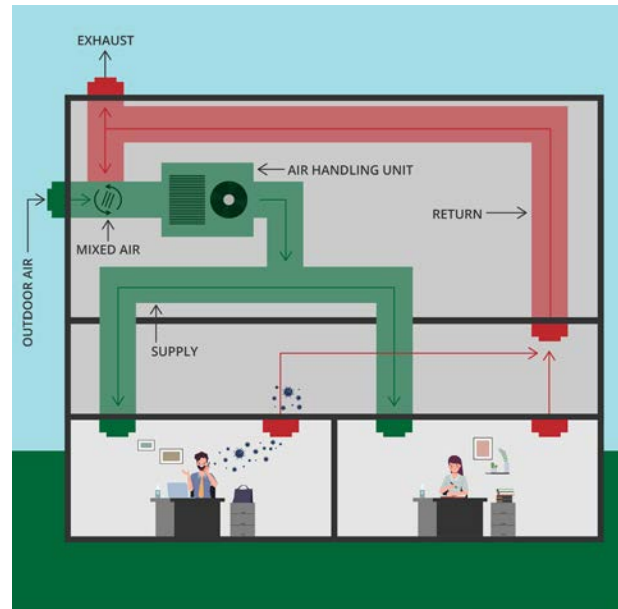

2: CONTAMINANTS LEAVE THE ROOM, AND ENTER RETURN AIR DUCTWORK

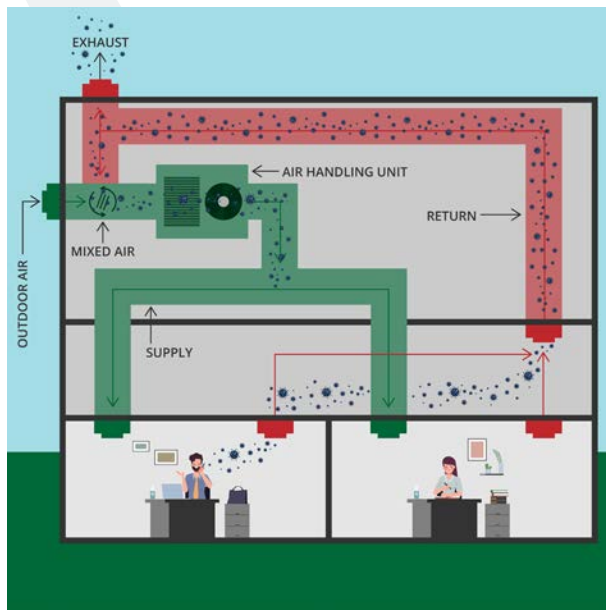

3: SOME ARE EXHAUSTED, SOME ARE FILTERED OUT, BUT SOME ARE RECIRCULATED THROUGHOUT THE BUILDING

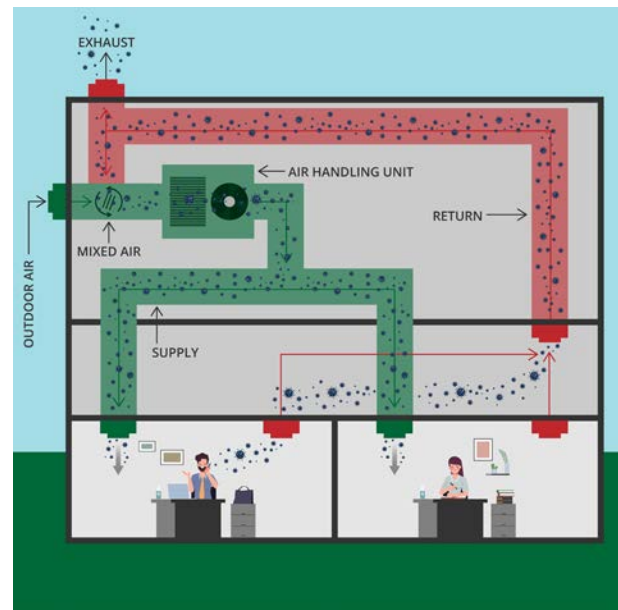

Dedicated Outside Air System

1: CONTAMINANTS ARE INTRODUCED IN A SINGLE ROOM; A SICK PERSON COUGHING, FOR EXAMPLE

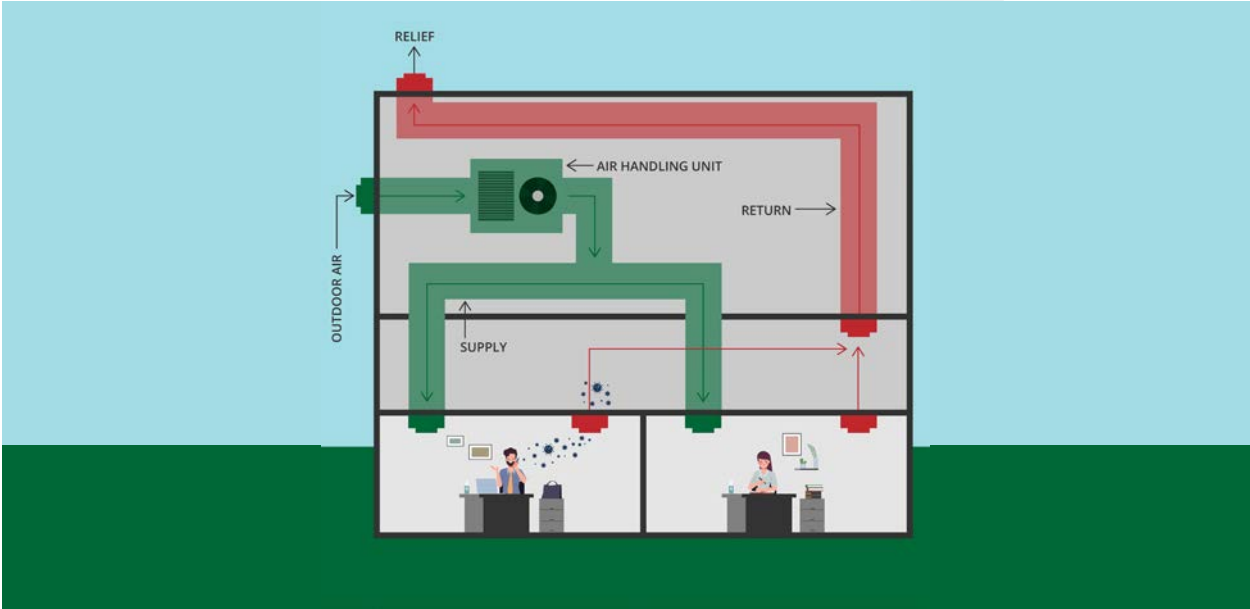

2: CONTAMINANTS LEAVE THE ROOM, AND ARE ALL EXHAUSTED OUTSIDE!

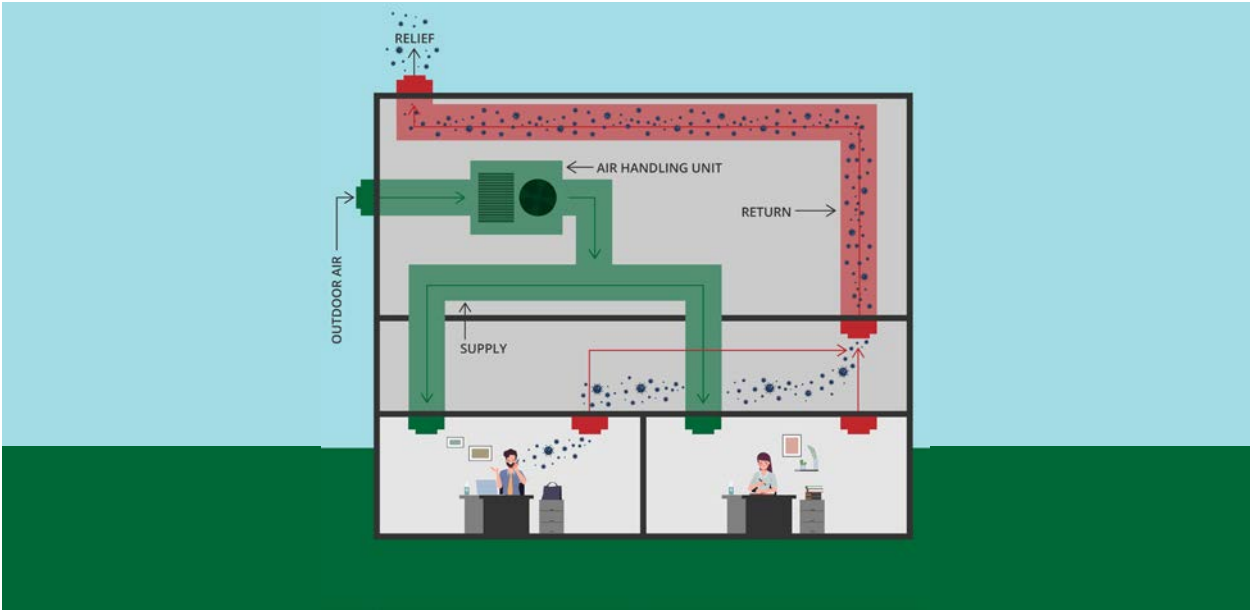

100% OUTSIDE AIR— FOR HEALTHIER BUILDINGS

Like an active chilled beam (ACB) or radiant system, induction displacement systems use 100% outdoor air with relatively little additional energy consumption, as opposed to a traditional all-air system where the energy penalty would be much higher.

The main reason for this is because these systems decouple sensible heating and cooling (temperature control) from ventilation and dehumidification. In other words, the cooling or heating capacity delivered to a space can be reduced while the levels of dehumidification and ventilation remain constant.

This means these three important factors (temperature, humidity, ventilation) of indoor air quality can be controlled to healthy and comfortable levels at all occupancy and load conditions — something not possible, or at least not practical, with most HVAC systems.

EXAMPLE: CLASSROOM

- 33' x 32' = 1056-square-foot floor area
- 30 occupants
- 18,000 BTUH sensible cooling load
- Ventilation rate ($E_z = 1.0$): 427 CFM
- Ventilation rate ($E_z = 1.2$): 356 CFM

CFM Required For...

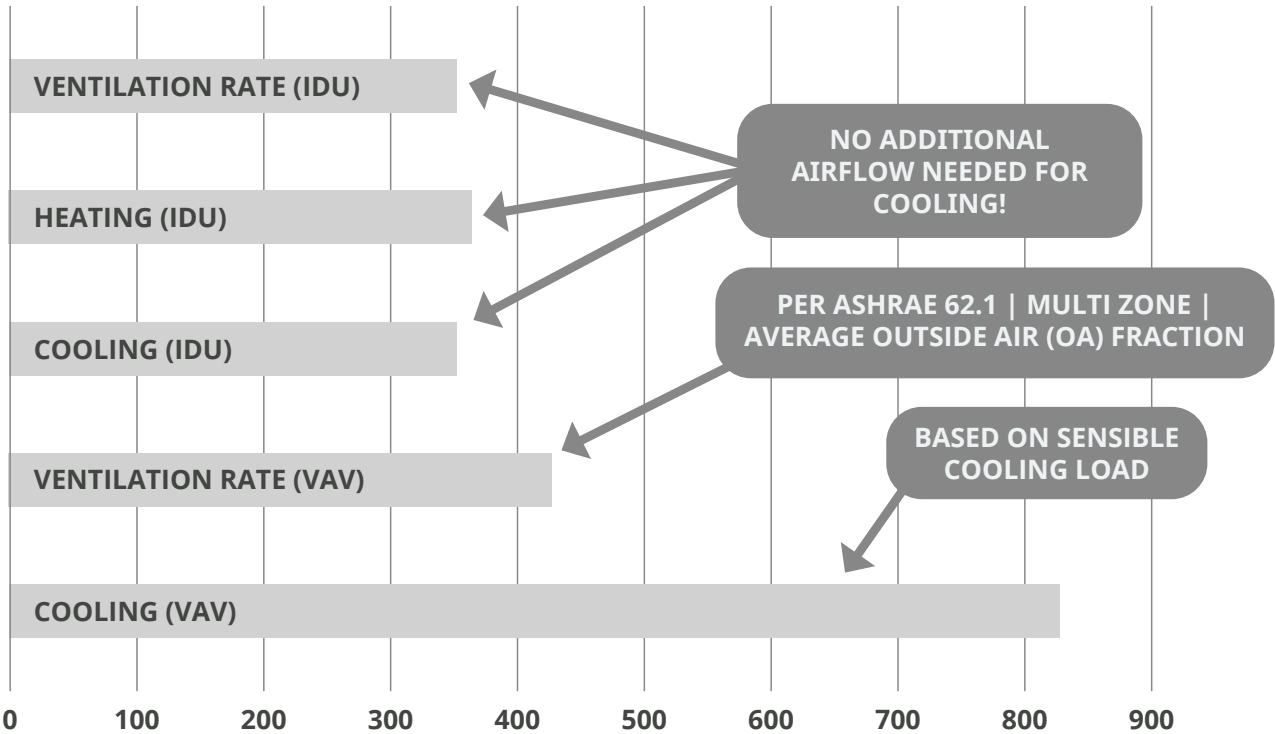

HUMIDITY CONTROL

Traditional Mixed Air System

Research has found that the optimal humidity range for healthy indoor environments is 40-60% RH. Humidity levels below or above that range are more susceptible to microbial growth and/or infection, plus, they are both uncomfortable. It is very common for buildings to be “clammy” under partial load in the cooling season, and uncomfortably dry through nearly the entire heating season.

In spite of the known benefits of humidity control, most HVAC systems don’t really control it well — the

cooling system lowers the temperature and the heating system raises the temperature. After that, the resulting humidity “is what it is”.

With all system types, there is additional cost, complexity and energy consumption associated with providing simultaneous temperature and humidity control. However, with induction displacement systems, the incremental cost and complexity is lower because humidity control is decoupled from temperature control.

OPTIMUM RELATIVE HUMIDITY FOR MINIMIZING ADVERSE HEALTH EFFECTS

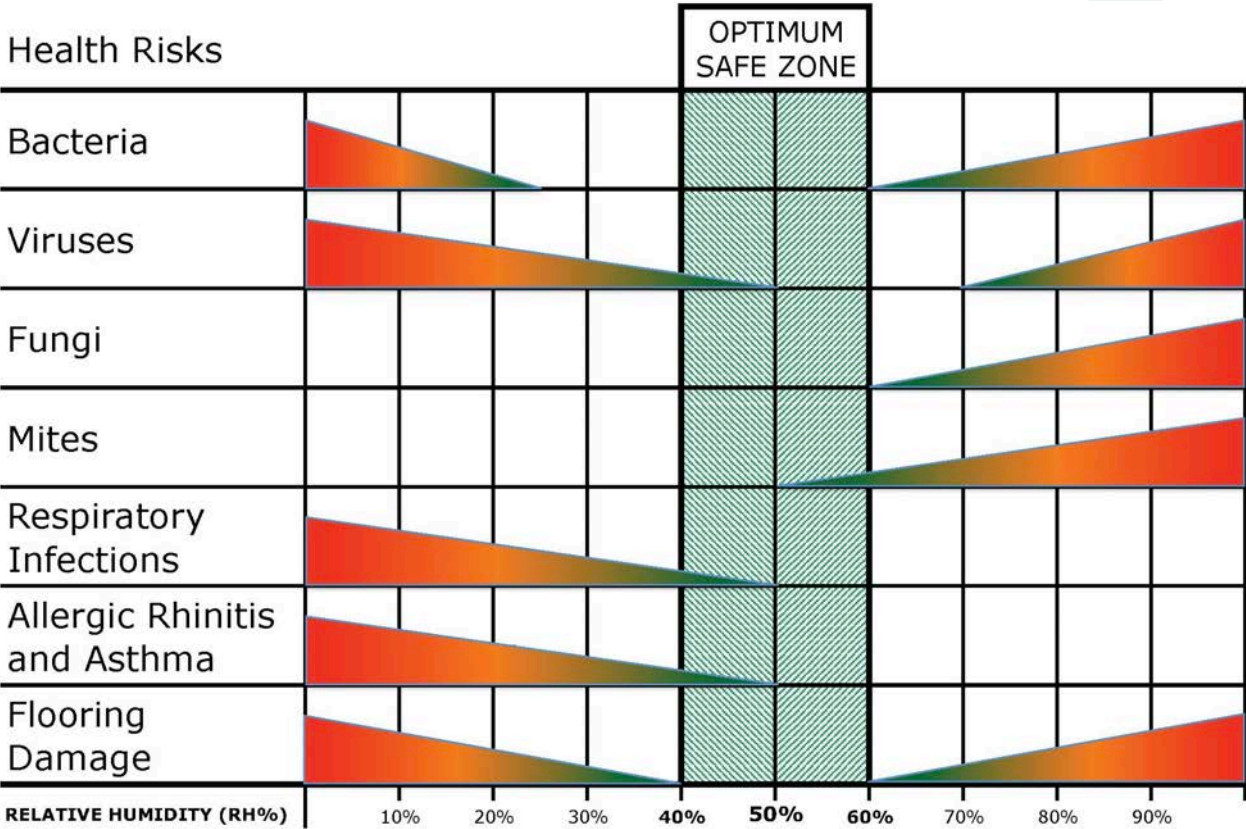

Source: Arundel A, Sterling E, Biggin J, et al - Indirect Health Effects of Relative Humidity in Indoor Environments - Environmental Health Perspectives Vol 65, pp.351-361 1986

DEHUMIDIFICATION

Typical VAV systems are designed such that humidity will be at a comfortable level on a cooling design-day, but under part-load cooling conditions, the humidity can rise above comfortable levels as the airflow is reduced in order to not overcool the room. On a cloudy day with mild temperature, the space sensible load will be far below its peak, but the latent load will be at or near design whenever the classroom is fully occupied.

IDU systems are designed such that comfortable humidity levels are maintained during all load conditions. This starts by ensuring that the design primary airflow rate to each classroom has sufficient latent cooling capacity to meet the space latent load. Meeting the space latent load depends on the difference in **absolute humidity** between the primary air and the room air. The system designer must select primary air conditions (and the associated AHUs) and design relative humidity levels that strike an acceptable balance between comfort, energy consumption, duct sizing and air handling system capital cost. The general goal is to be able to meet the latent loads with the same or “not too much” more primary air flow than is required for ventilation.

The table below shows the primary air CFM required to meet a latent load of 6000 BTUH, for a wide range of primary air dew points and design room humidity levels. Design primary air dew points of 50°F or less are generally recommended to keep humidity levels comfortable without requiring excessive primary air flow.

As of the 2019 version, ASHRAE 62.1 (Section 5.10) requires buildings to limit the indoor dew point temperature to 60°F, whenever the outdoor air dew point is above 60°F. ACB/IDU systems are designed to do this by default, whereas most other systems are not.

PRIMARY AIR DEW POINT (°F)	PRIMARY CFM REQUIRED TO MAINTAIN ROOM RH (75° ROOM TEMP, 6000 BTUH LATENT LOAD)				
	50% ROOM RH	52.5% ROOM RH	55% ROOM RH	57.5% ROOM RH	60% ROOM RH
	55.1°F ROOM DEW POINT	56.5°F ROOM DEW POINT	57.8°F ROOM DEW POINT	59°F ROOM DEW POINT	60.2°F ROOM DEW POINT
54	3333	1463	923	689	544
52	1200	822	625	503	422
50	766	592	484	407	351
48	565	464	395	342	302
46	454	387	339	298	267

Recommended design condition to minimize primary airflow in humid climates

Max design RH allowable for comfort, per ASHRAE 55

Design dew point too high, per ASHRAE 62.1

CONDENSATION PREVENTION

More care is taken to satisfy latent loads in these systems because there are cooling coils in the occupied spaces, and the intent is to keep them dry.

Keeping coils dry is important because any wet surface is a source of microbial growth. ASHRAE 62.1 specifies that any surface that is designed to be wetted must have a MERV 8 or higher filter upstream of that surface. This should be avoided because such filters substantially reduce the performance of IDUs. Further, filter changes introduce a regular maintenance cost that would otherwise not be there, and effectively cleaning a condensing coil is much more difficult than vacuuming the dust off a dry coil.

In order to keep coils dry, the dew point temperature of the room air must be kept below the entering water temperature of the coils.

Once the design (maximum) room air dew point is determined, the entering CHW temperature should be set to 1–2°F above that value. This is why typical EWTs are in the range of 58–61°F.

VERTICAL TEMPERATURE PROFILE

The flow rate required to cool a space with a given load is proportional to the difference between the supply air and exhaust air temperatures. In stratified ventilation systems, the exhaust temperature is unknown and difficult to predict. The room temperature gradient varies with many factors, including: heat load, distribution of heat load, ceiling height, supply air velocity and temperature, location and activity level of occupants, and furniture layout in the room.

An approximation that works well enough for typical applications with 9–12' high ceilings is the "50% rule" – which states that half the (supply – exhaust) temperature difference is dissipated by mixing near the supply air outlet. The other half of the differential is roughly linear from floor to ceiling, once you are more than a few feet from the supply outlet.

ASHRAE Standard 55 (Thermal Environmental Conditions for Human Occupancy) specifies a maximum allowable vertical temperature stratification of 1°F per vertical foot in occupied zones. Combining this with the 50-50 rule, the maximum (Exhaust - Supply) temperature differential that can be assumed is equal to twice the ceiling height, in feet. For example, if the ceiling height is 9', the max difference from the floor to ceiling is 9°F, and the difference between the supply air and temperature at the floor is also 9°, for a total (exhaust - supply) differential of 18°F, which is the maximum that can be used to calculate the supply air flow rate required for sensible cooling.

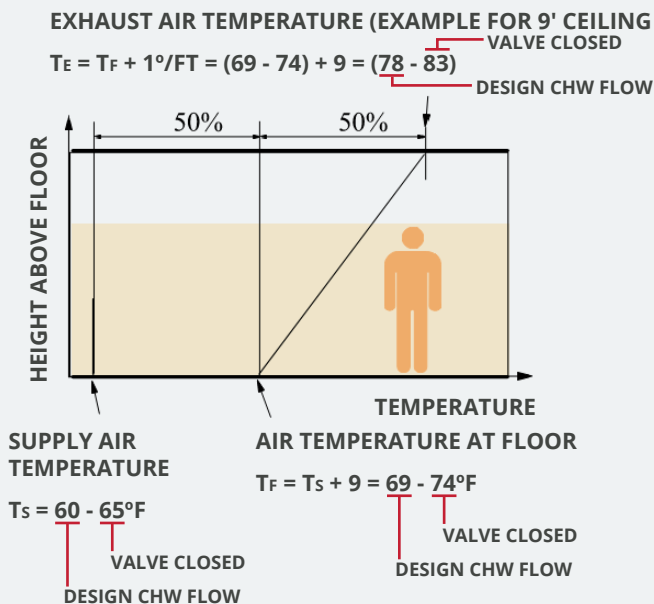

NOTE: The 50-50 rule is an approximation, and it will not always be what actually occurs in a real room. IDUs with chilled water coil provide flexibility by providing supply air that is "not too cold" with valve closed, and "just cold enough" to maintain desired temperature at the thermostat as the valve opens. For this to work well, it is critical to use properly sized CHW control valves with a slow acting proportional control signal.

If heating only IDUs are used, the 50-50 rule should be used to determine the (constant) supply air temperature that will result in the desired temperature at head level.

OTHER DESIGN CONSIDERATIONS

MAX SPACE SENSIBLE COOLING LOAD FOR THIS SYSTEM?

This is limited by comfort. The limiting case is when the entire perimeter wall is filled with IDU units supplying air at 70 FPM. The cooling capacity would be calculated by taking that corresponding CFM of supply air and using the max temperature differential described above, which is a function of ceiling height. With **9' ceilings, the lowest recommended for displacement ventilation**, the cooling load limit is about 750 BTU/h **per foot of perimeter wall**.

LOCATION OF OCCUPANTS

From above, the air temperature near the floor will be cooler right next to the outlet of the units. Therefore, it is recommended to not locate stationary occupants right next to the units, desks should be placed no closer than 2–3' away. In addition, do not place obstructions directly in front of the supply air outlet. The first 6" of space in front of the supply outlets should be left unobstructed.

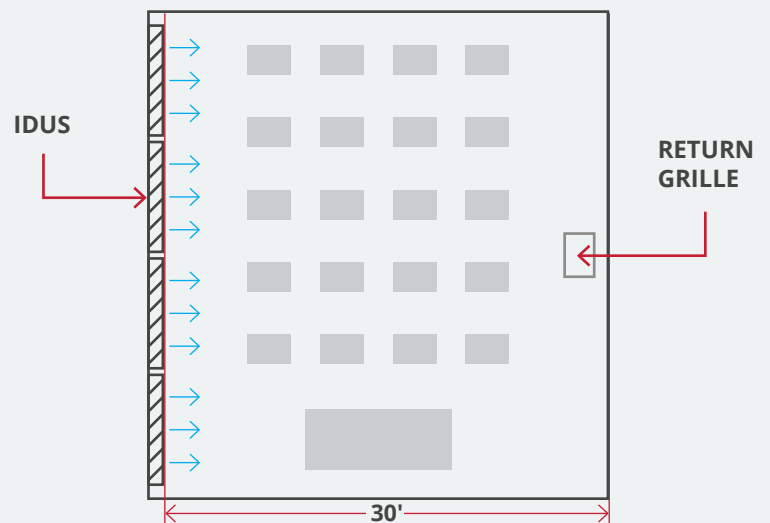

LOCATION OF RETURNS

Return (exhaust) air grilles must be located in the ceiling for stratified ventilation to work properly. If the ceiling height is not equal throughout the room, the return(s) must be located at the highest point in the room. Ideally, they should be placed at the opposite side of the room as the IDU units.

ROOM DEPTH

Supply air from displacement ventilation outlets has been found to penetrate about 30' into the zone. This is the maximum recommended depth from the outlet of the IDUs to the other side of the room. For rooms significantly deeper than this, consider laying out units along multiple walls.

REHEAT

There should be no need for any re-heat in a properly designed and operated IDU system. From above, the air temperature around occupants should never get below 70°F in cooling mode with the control valve closed. Reheat would also make the air supply too warm for effective displacement ventilation.

Classroom Selection Example | IDU10

ROOM DIMENSIONS: 33' long (exterior wall) x 32' wide

NUMBER OCCUPANTS: 30

LATENT LOAD: 6000 BTUH (200/person)

SENSIBLE LOAD: 16,800 BTUH

HEATING LOAD: 13,500 BTUH

OA VENTILATION RATE: 355 CFM (ASHRAE 62.1)

CEILING HEIGHT: 9 ft

Design Conditions:

COOLING: 51°F dry bulb/49.3°F wet bulb (48°F dew point) Primary Air

HEATING: 60°F Primary Air

ROOM DESIGN: 75/57.5% (cooling) 70/40% (heating)

EWT: 60°F (cooling) / 120°F (heating)

SYSTEM INFORMATION:

- AHU with DX cooling, hot water heating coil, energy recovery, VSDs.
- Low-ambient, air-to-water heat pump for all heating and producing chilled water for the IDU units
- IDU10 units in each classroom. Upstream VAV box for air control, two-way control valves for cooling and heating coils. Temperature and occupancy sensing in each classroom.

1. CALCULATE DESIGN PRIMARY AIRFLOW RATE

This is the greater of the ventilation rate and the CFM required to meet the design latent load using the design primary air and room air conditions. In this case, 342 CFM primary air is required in order to meet the latent load so the 355 CFM required for ventilation becomes the design primary airflow rate. Note that because of the room design condition and relatively low primary air dew point, we were able to reduce the air system to the smallest possible size.

2. DETERMINE SUPPLY AIRFLOW FOR SENSIBLE COOLING

From discussion on previous page, with a 9' ceiling height, the maximum temperature differential to assume for sensible cooling is 18°F. $16800 / (1.085 * 18) = 860$ CFM supply air

3. DETERMINE QTY & LENGTH OF IDU10 UNITS REQUIRED

- A.** Determine outlet area required to deliver 860 CFM at an acceptable velocity. Using 60 FPM velocity: $860 \text{ CFM} / 60 \text{ FPM} = 14.3 \text{ sq ft}$
- B.** Determine total (nominal) IDU Unit Length required to provide that area. Each foot of unit length has 0.63 sq ft of outlet area. $14.3 / 0.63 = 22.7 \text{ ft}$ unit length.

Keeping unit lengths in the room the same, an acceptable layout would be (4) 6' units. Primary air will be evenly split between the 4 of them for 90 CFM each (rounding up).

- C.** Verify that the chosen layout will fit in the space available. 24' of units is well within the 31' of perimeter wall available. About 3' of additional space will be needed to fit (2) duct/pipe chases in the room, which brings the required space up to about 27'.

4. MAKE UNIT SELECTION—PRIMARY AIR PRESSURE & NOZZLE CONFIGURATION

- A.** Unit length (6') and primary airflow (90 CFM) is known. Next step is to find the primary air pressure drop & nozzle config that will result in the desired supply airflow rate ($860 / 4 = 215$ CFM per unit).

Enter the unit length and primary air flow into the Dadanco selection software. With "selection mode" set to "Select target pressure", enter a "target pressure" of 0.35" and see what the resulting supply airflow rate is. Adjust the target pressure until the supply airflow is equal to or slightly above 215 CFM. In this case 0.35" pressure results in 224 CFM, which is a velocity of 59 FPM.

- B.** Check supply air temps with valves closed, in both cooling and heating mode. Check that they both meet the following criteria:

1. Temperature is at least 4°F below the room set point (for thermal stratification)
2. Temperature is 63°F or higher (for comfort)

In heating mode, the goal is to have the primary air only as cold as required to achieve thermal stratification. Select design primary air temp (in heating mode) accordingly.

In cooling mode, it is recommended to have the supply air temp with valve closed to be at least 63°, but the higher the better (up to the max of 4° below set point). 60°F should be the minimum temperature at design chilled water flow. Therefore, the further above 60° the temperature with valve closed is, the more temperature control you get from the control valve.

In this case, the cooling supply temp with valve closed works out to 65.4°, which is good, and the heating supply air temp is 66°, which is just low enough.

5. DETERMINE THE DESIGN CHILLED WATER FLOW RATE

In cooling mode, the thermostat will modulate the valve to vary the supply air temperature in response to cooling demand. From previous step, temperature with valve closed will be 65.4°. Select GPM such that the temp with design water flow will be equal to or a little above 60. In this example, 1.0 GPM gives a design supply temp of 60 degrees.

6. SELECT UNITS FOR HEATING

1.5 GPM is the general flow rate recommended for IDU natural convection heating coils. Check heating capacity of the (4) 6' units with 1.5 GPM each. From the software, 4 units x 3522 BTUH = 14,088 BTUH, which meets the heating load. If heating load wasn't met, options are: add heating only units or heating shelves to extra space, add other supplemental heating devices (fin-tube on other walls, radiant panels), reset water temperature upwards when needed (if possible).

BASIC ROOM CONTROL SEQUENCE | IDU10

Based on Room & System Described in the Previous Example

CHILLED WATER CONTROL VALVE (2-WAY MODULATING, NORMALLY CLOSED)

- If cooling system is enabled and temperature rises above cooling setpoint, the chilled water valve modulates in order to maintain temperature setpoint.

Note: Modulating control valves with proportional control are recommended over two-position valves because they allow the supply air temperature to gradually change as the temperature read by the thermostat goes above and below the setpoint. This will be perceived as more comfortable than the relatively fast and large temperature swings that would happen as a valve cycles open and close.

HOT WATER CONTROL VALVE (2-WAY NORMALLY CLOSED)

- If heating system is enabled and temperature drops below the heating setpoint, the hot water valve modulates in order to maintain temperature. Hot water valve and control can be modulating or 2-position.

VARIABLE AIR VOLUME (VAV) TERMINAL

- Occupied flow setpoint is 360 CFM, flow is constant volume when the room is occupied. Unoccupied flow setpoint is 0 or lowest allowed by code.

NOTE: Constant volume primary air is recommended in this case because the primary CFM required for ventilation is equal to that required for dehumidification. If that were not the case, it is recommended to use 2 occupied flow set points - one at design flow, and another at minimum ventilation flow, to be used when outdoor air dew point is low enough to maintain design room dew points. In many US climates (Midwest, northeast), this essentially means the cooling season flow set point is the design (dehumidification) flow, and the heating season set point is minimum ventilation.

START-UP

Cooling: VAV maintains design flow. Chilled water valve remains closed until space dew point is at or below setpoint, at which time, the chilled water valve opens fully. VAV and chilled water valve resume normal operation when both temperature and dew point are at or below setpoint.

Heating: VAV maintains design flow. Hot water valve opens fully. VAV and hot water valve resume normal operation when temperature is at or above setpoint.

BASIC SYSTEM CONTROL SEQUENCE

Based on Room & System Described in the Previous Example

PUMPS (SAME FOR CHILLED WATER AND HOT WATER)

- Variable frequency drive (VFD) modulates in order to maintain pressure setpoint. Pressure sensor installed in system piping. Setpoint is the pressure required such that each classroom receives at least design water flow rate with control valve fully open. Setpoint determined during system balancing.

AIR HANDLING UNIT | FANS

- Supply fan VFD modulates in order to maintain pressure setpoint. Pressure sensor installed in system ductwork. Setpoint is the pressure required such that each classroom receives at least the design primary airflow rate with (VAV) terminal fully open. Setpoint determined during system balancing.
- Exhaust fan VFD modulates to track supply fan, with an offset to maintain positive building pressurization.

HEAT PUMP(S):

- This would be a 2-pipe changeover system where the heat pumps make either chilled or hot water at any given time. If any zones require heating, the heat pumps make hot water. In shoulder seasons, zones that require cooling still get it from the primary air. In heating or cooling mode, the heat pumps maintain the water set point temperature. In this example, 60°F in Cooling, 120°F in heating.
- Each zone will use a single 3-way valve, or a pair of 2-way control valves off the single supply pipe to direct water to the proper coil based on cooling or heating. Both coils are piped to the same single return pipe. The pair of 2-way valves is recommended for controllability if the design CHW and HW flows are different.

AIR HANDLING UNIT | COOLING

- Cooling modulates to maintain primary air dew point at or below setpoint (48°F, adjustable).
- Cooling modulates to maintain primary air temperature at or below set point which will adjust between a minimum of the cooling design set point, and a maximum of the heating design set point, varying based on overall demand from zones. This is secondary to dew point setting. Used for when the OA dew point is below setpoint without cooling.

- During morning cool-down, cooling operates at 100% capacity until each zone is at or below temperature and dew point setpoints.

AIR HANDLING UNIT | HEATING

- When the heat pump(s) are in heating mode, the hot water valve modulates to maintain primary air temperature set point. Set point will adjust between a minimum of the cooling design set point, and a maximum of the heating design set point, varying based on overall demand from zones.
- During morning warm-up, heating coil is 100% open until each zone is at or above temperature setpoint.

NOTE: Example control sequences are for informational purposes only, to explain the basic functionality of an IDU system. They are not intended to be complete sequences with sufficient detail to operate any real system.

This example is one possible system configuration of many. IDU units can be applied within a variety of system configurations as long as they are supplied with air and water at the appropriate temperatures/humidities for the application.

IDU20 and IDU30 have similar, but different selection procedures. Contact your local Dadanco representative for information and assistance.

CABINETS

The cabinet design is the same regardless of which induction displacement unit a project requires. Induction displacement unit cabinet is highly configurable to meet the architectural requirements of every project.

- Heavy durable construction: 14 gauge structural components provide plenty of strength and can support the weight of adults standing on top.
- High quality powder coat finish: Ten standard colors, custom color matching available, two textured finish options.
- Flexibility and customization: Components factory selected/configured for the requirements of every room based on field measurements and design intent provided by the contractor and design team
- No field cutting or sharp edges: Parts are made to order for each application — no cutting ever required.



CABINETS COMPONENTS:

- **Unit enclosure:** Each IDU unit of a particular length comes with associated enclosure components: Front panel, top panel, and kick plate. These are primarily supported by mullions — one on each side of every unit.
 - **Mullions:** These provide most of the structural support of the cabinets. There are three basic kinds: open-end, closed-end, and center.
 - **Open-end mullions:** These are used whenever a run of cabinets connects to a side wall. One side attaches to the side wall, the other side has a flange to support the adjacent top panel.
 - **Closed-end mullions:** These are used whenever a run of cabinets ends in open space. One side is a closed/finished endcap, the other has a flange for supporting the adjacent top panel.
 - **Center mullion:** These are used between any two consecutive units. Each side has a flange for supporting adjacent top panels.
- Each of these mullion types is customizable in length in order to accommodate any desired cabinets layout. Mullions 12" and longer can be made with front access panels and/or top cutouts to fit around obstructions like duct, pipe or columns.
- Minimum length of end mullions (open and closed) is 1/2" and minimum length of center mullions is 1".
- Mullions can be made up to 32" for open end, and up to 43" for center and closed end. Mullions are sized to fill up extra space, as well cover up and provide access to duct/pipe/valves, etc.

DUCT AND ENCLOSURE LAYOUT

Each IDU has an 8" elliptical duct connection on one or both ends. No more than two units should be supplied in series from a single duct. Typical classrooms require three or four units, and are usually laid out in one of two basic ways:

1. DUCT DROPS ON BOTH ENDS:

After the zone air control device (typically variable air volume box), the supply duct splits in two above the ceiling, and each is routed to one end of the perimeter wall. Each drops down through the room to near floor level to feed the units. To minimize noise, the ductwork should be sized to keep air velocities low. 250 CFM is the max recommended flow for each of the two duct drops, which should be 8" diameter to match the inlet of the IDUs. The duct

drops should be round, hard duct, and connections to the elliptical connections on the IDUs should be made with 8" flexible duct. The ductwork is covered either by a field constructed chase, or by a Dadanco-supplied chase that matches the IDU cabinetry.

Field-constructed chases are sized to fit all the ducts, pipes, etc. that they cover, and access panels are built in to provide any required access. With the total room width and chase widths known, the remaining distance between the two chases is the wall-to-wall distance that must be covered by IDU enclosures. These dimensions can be provided to Dadanco for sizing mullion lengths in each room, or field-constructed chases

can be dimensioned in order to standardize around common mullion sizes in each room — often the shortest possible.

With chases already on both sides, this installation lends itself to reverse-return piping. Supply pipes are run down one chase on one side of the room, and return pipes are run down the other side. Accordingly, no balancing valves are required at the units.

The image below is an example installation of (three) IDU units using the smallest possible mullions and field constructed chases (not shown). The length of the field chases would be coordinated such that the cabinet below fits between them.

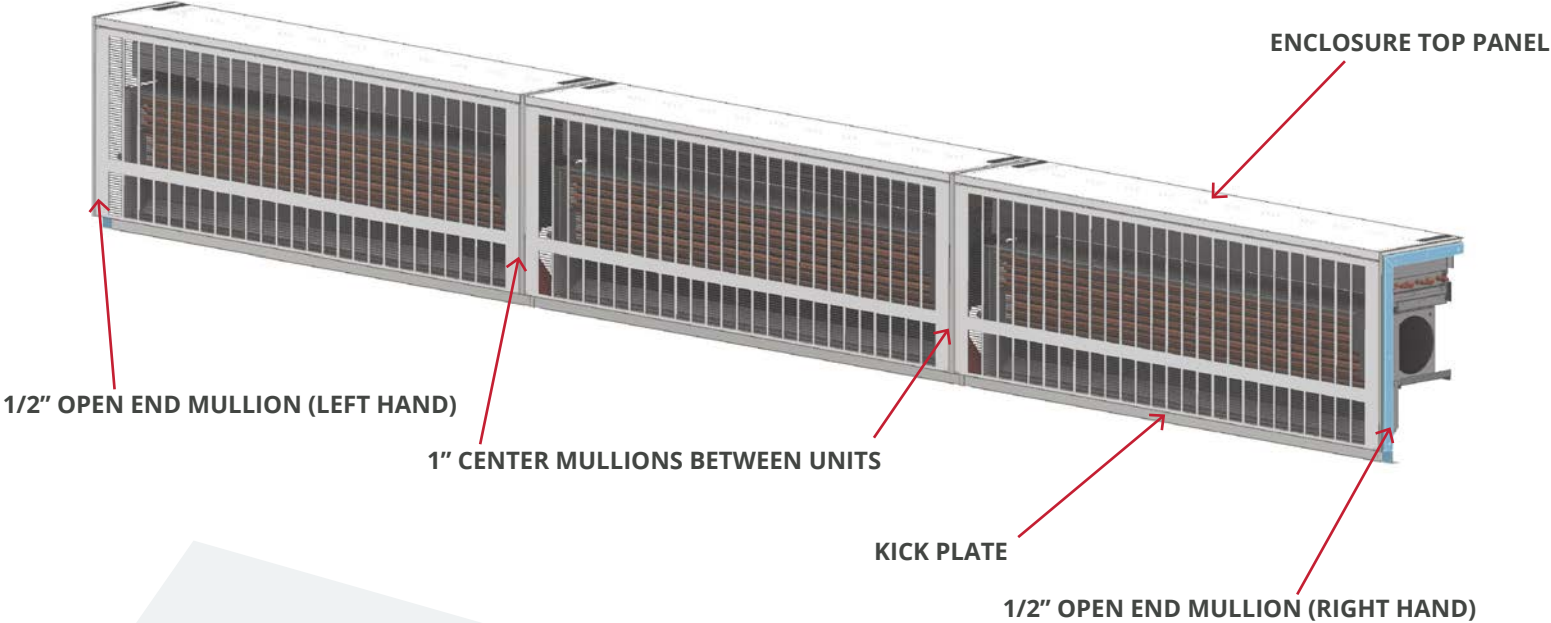

2. MIDDLE DUCT: There is a single duct drop in the room and a chase going down somewhere in the middle of the exterior wall. The ductwork is covered by a Dadanco-provided chase and enters through the top of a longer center mullion with top duct cutout and front access panel. Center mullions (shown below) and closed-end mullions use front duct chases that attach to the rear wall only.

250 CFM is still the max recommended flow to enter into a single IDU or a group ducted in series. Unless it is a small room, this means that IDUs will have to be on both sides of the duct drop. The Drop itself should be sized for the total flow, usually at least 10" round, with a fitting at the bottom, behind the access panel that splits into two 8" connections. The duct cutouts in the top of the mullions are about 14" deep, so 12" is the largest size insulated duct that can fit.

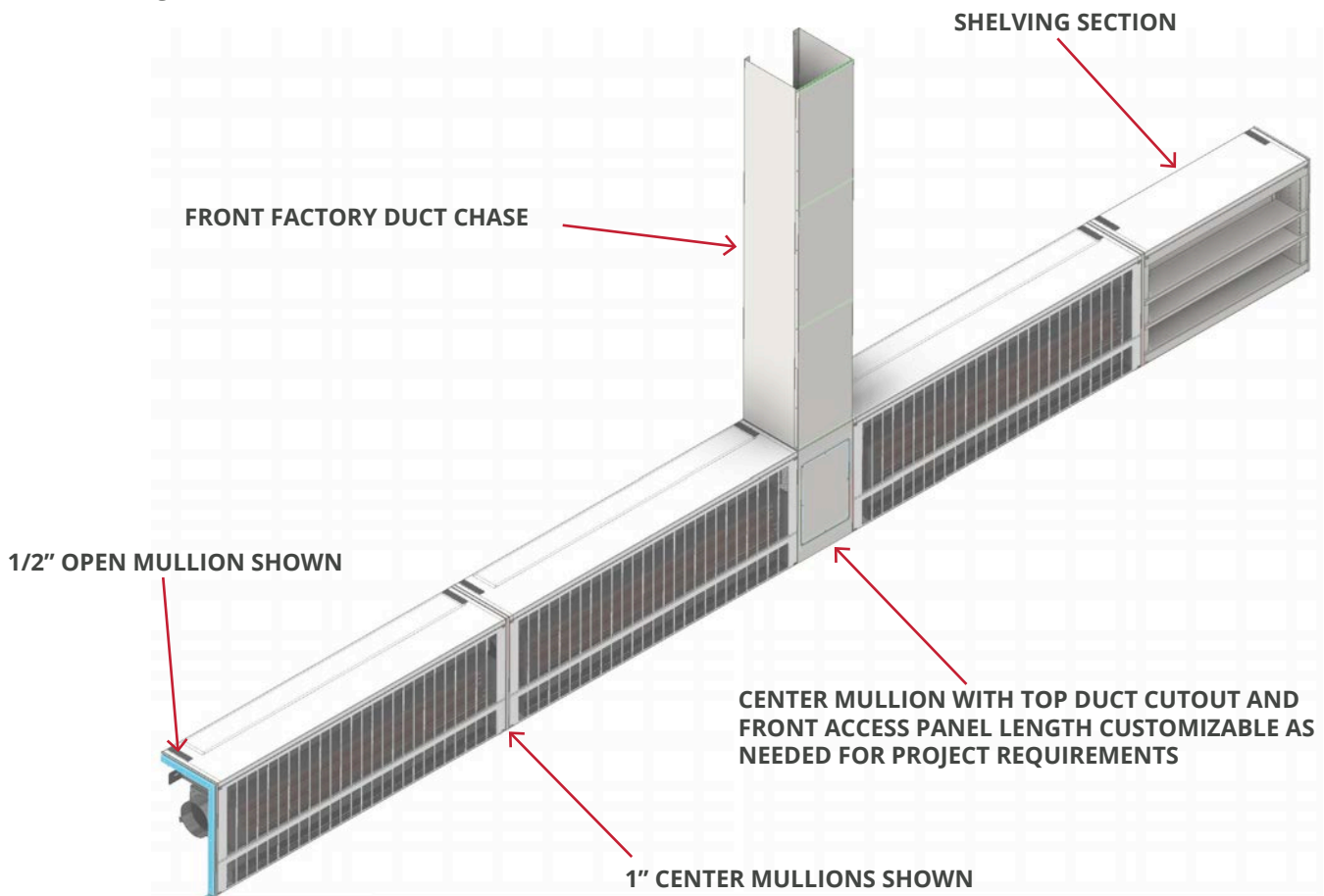

Factory chases are designed to be flush with their associated mullion, both in width and depth. Each chase comes with two wall supports that are fixed to the walls. The chase then overlaps the wall supports and is attached to each by sheet metal screws. The overlap allows the chases to be installed flush with the mullion, even if the walls are not square. Open end mullions use corner duct chases that attach to rear and side walls.

THE LUXTON-REED CENTER
47 WESTFIELD INDUSTRIAL PARK ROAD
WESTFIELD, MASSACHUSETTS 01085

413.568.9571
INFO@DADANCO.COM

  DADANCO

 DADANCOHVAC



© Dadanco 2022 All Rights Reserved
E-2-0122
US9551496B2
US9982899B2

